

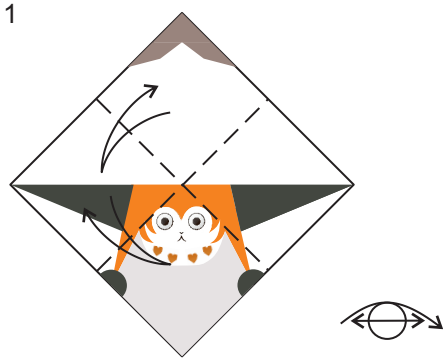

PAISSA

Start with a square coloured side up.



Fold and unfold the square in half lengthwise. Then turn the paper over left to right.

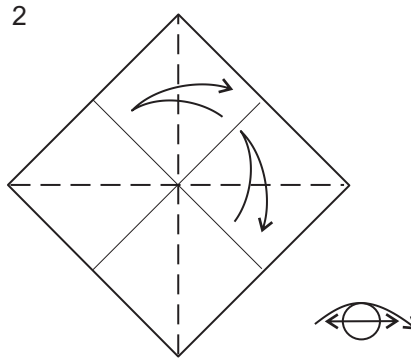

Fold and unfold the square in half diagonally. Then turn the paper over left to right.

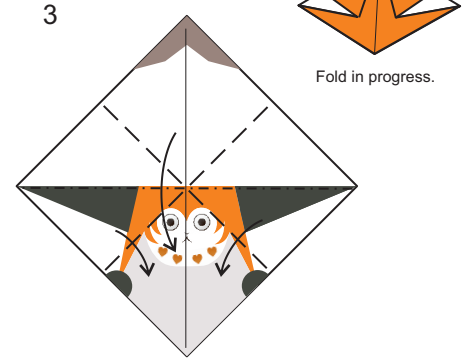

Fold the upper section down and fold the sides in making a preliminary base.

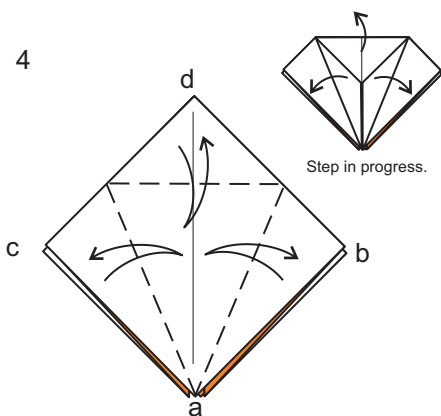

Fold the sides in diagonally to the middle at (b) and (c). Then fold the upper corner over at (d). Then unfold.

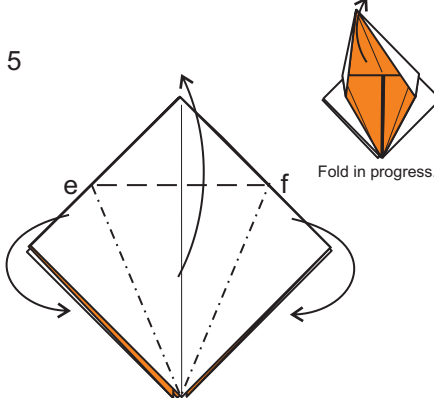

Fold the upper layer up along the line between (e) and (f). This will cause the edges to fold in and touch.

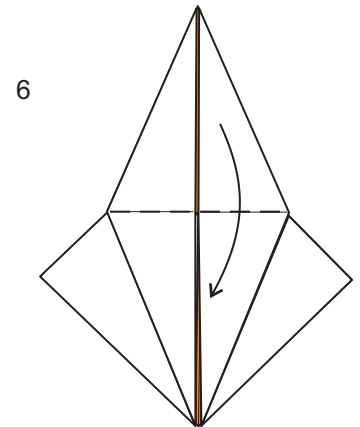

Fold the point back down again.

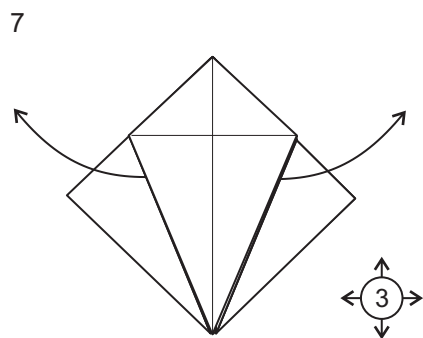

Unfold the model back to a square. (Step 3).

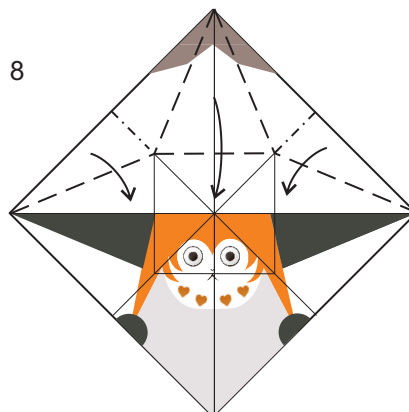

Fold the upper section down. At the same time fold in the edges and flatten the section.

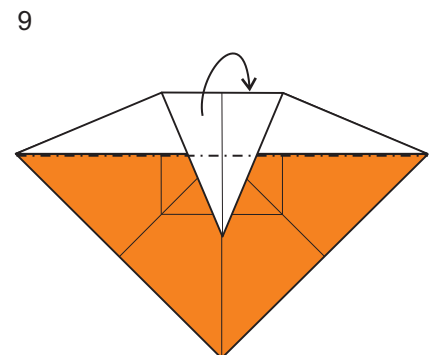

Fold the upper section behind.

© 2010 - 2017 SQUARE ENIX CO., LTD. All Rights Reserved. NOT FOR SALE.

STORMBLOOD, HEAVENSWARD and A REALM REBORN are registered trademarks or trademarks of Square Enix Co., Ltd. FINAL FANTASY, FINAL FANTASY XIV, FFXIV, SQUARE ENIX and the SQUARE ENIX logo are registered trademarks or trademarks of Square Enix Holdings Co., Ltd.

Diagrams © 2017 Creaselighting Limited www.creaselighting.co.uk

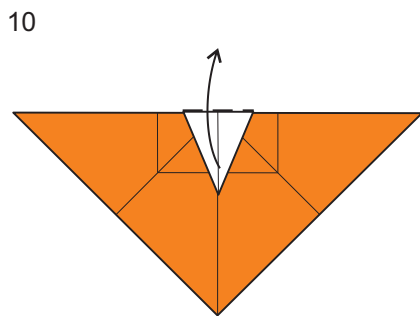

10
Fold the corner up. This may have flipped up in the previous step.

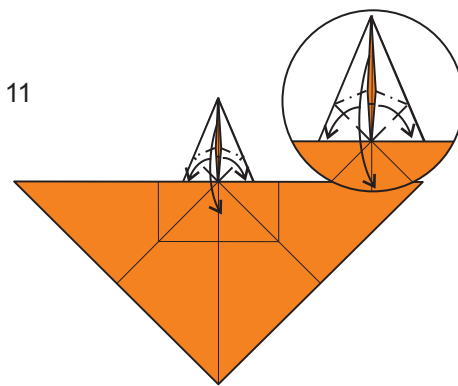

11
Open out the paper in the point and fold it down.

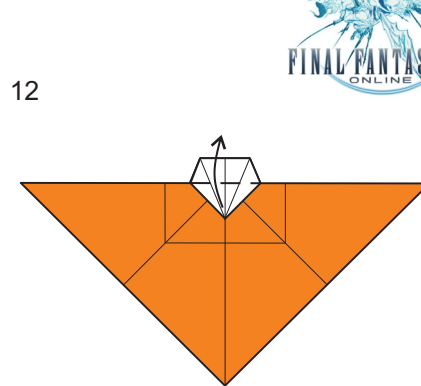

12
Fold the corner back up.

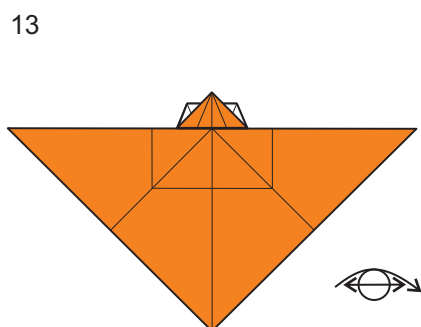

13
Turn the model over left to right.

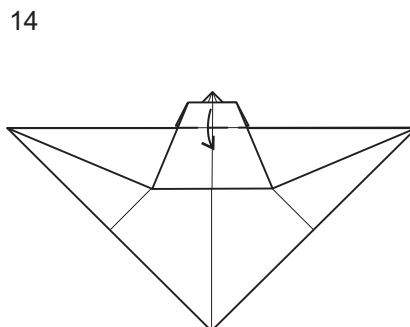

14
Fold the front layer of the upper section down.

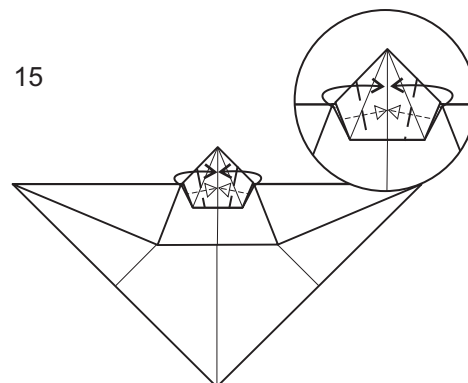

15
Fold the edges in to the middle crease, this will cause the paper in the layer beneath to open and squash.

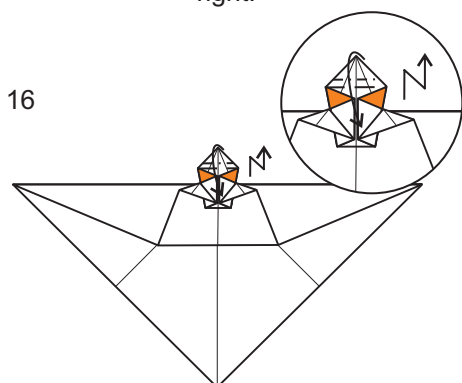

16
Fold the upper corner down and up again making a zig zag fold.

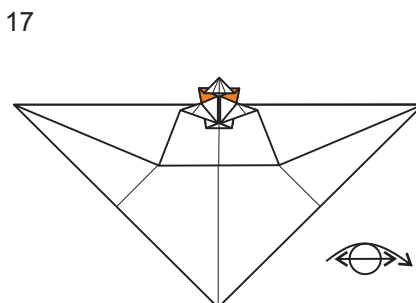

17
Turn the model over left to right.

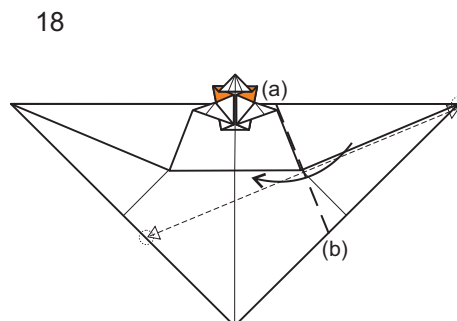

18
Fold the outer corner in along the inner folded edge of the upper layer (a-b).

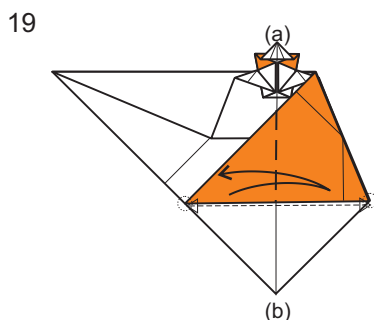

19
Fold the upper layer over along the middle crease (a-b) in the layer beneath. Crease, then unfold.

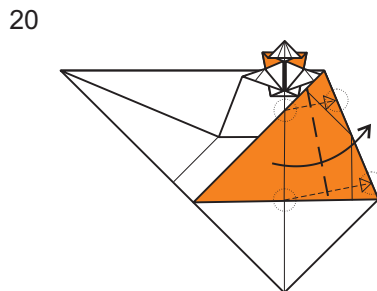

20
Fold the corner back over to align the crease made in the previous step with the outer edge.

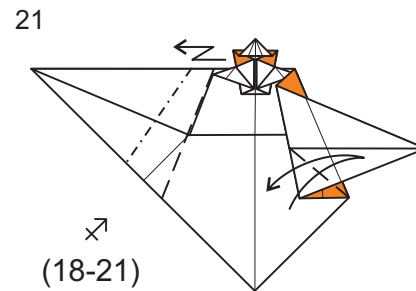

21
(18-21)

Fold and unfold the corner. Then Repeat steps 18 to 21 on the other side.

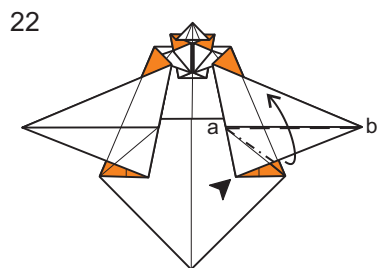

22
Fold the lower edge of the point up along (a-b) along the folded edge above. This will cause the lower corner to squash.

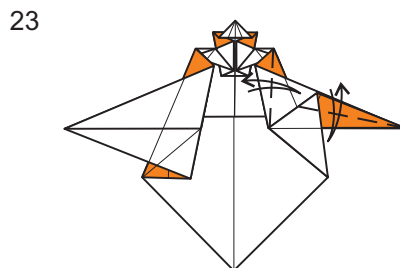

23
Fold the upper layers of the corners over, crease, and unfold.

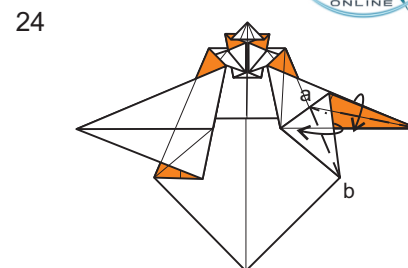

24
Fold the upper layer of the edge (a-b) over. This will cause the upper edge folded in the previous step to fold over.

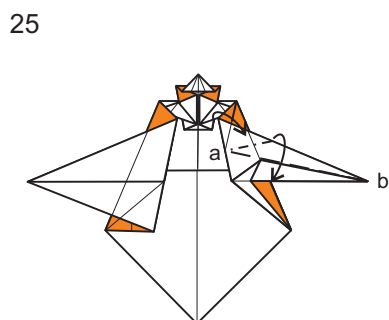

25
Fold the upper edge down at (a-b) over the folded edge. This will cause the upper corner to fold and squash.

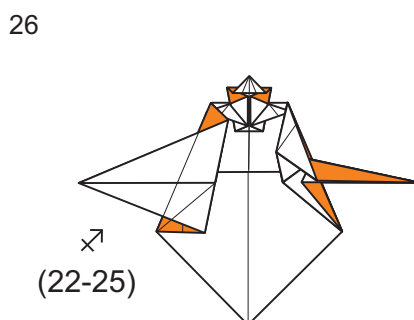

26
Repeat steps 22 to 25 on the other side.

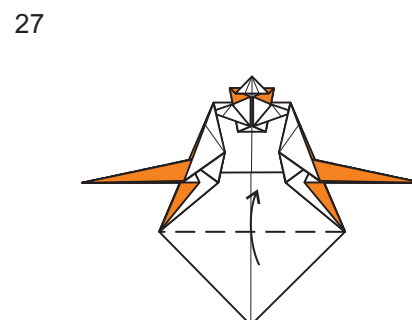

27
Fold the lower corner up and tuck it beneath the two side sections.

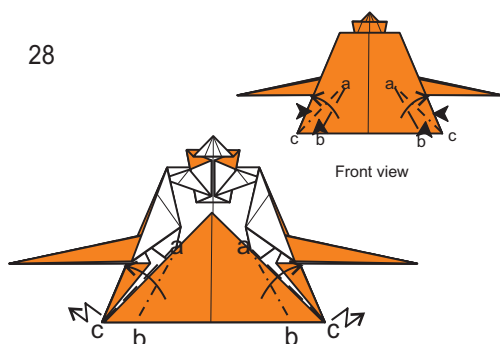

28
Pinch the outer sides along (a-c) and fold them in along (a-b), making two crimp folds. This will shape the body.

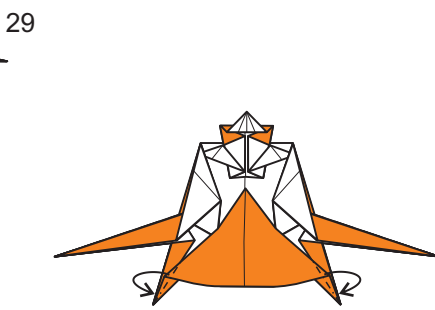

29
Fold the corners behind to lock the folds made previously.

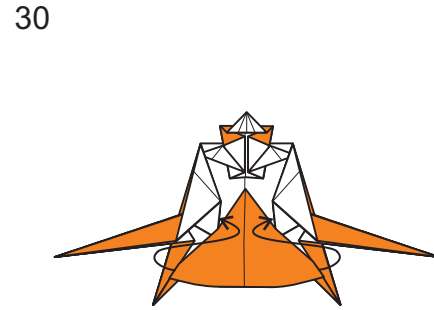

30
Fold the two side sections to the front and over the middle folds.

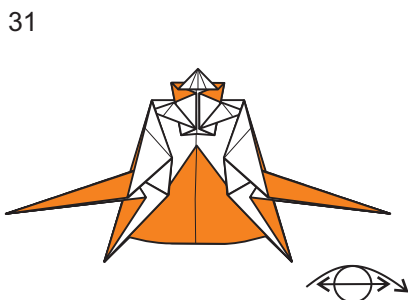

31
Turn the model over, left to right.

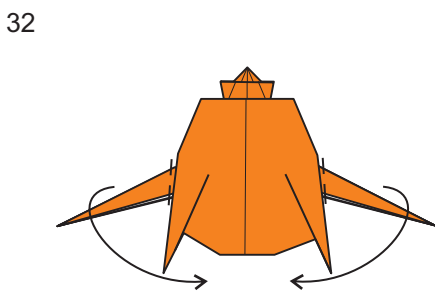

32
Fold the arms in and make a crease adjacent to the body. Then curl the arms.

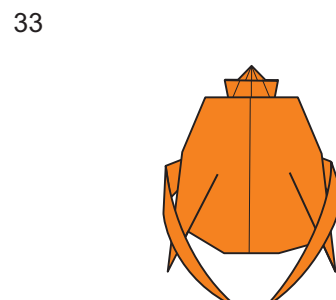

33
Complete.



Paissa

Cut out the square to make the model.



© 2010 - 2017 SQUARE ENIX CO., LTD. All Rights Reserved. NOT FOR SALE.

STORMBLOOD, HEAVENSWARD and A REALM REBORN are registered trademarks or trademarks of Square Enix Co., Ltd.
FINAL FANTASY, FINAL FANTASY XIV, FFXIV, SQUARE ENIX and the SQUARE ENIX logo are registered trademarks or trademarks
of Square Enix Holdings Co., Ltd.

Diagrams © 2017 Creaselighting Limited www.creaselighting.co.uk