

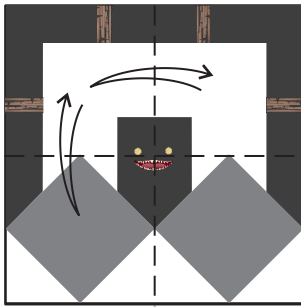

SPRIGGAN

Start with a square coloured side up.

1



Fold and unfold the square in half lengthwise.

2

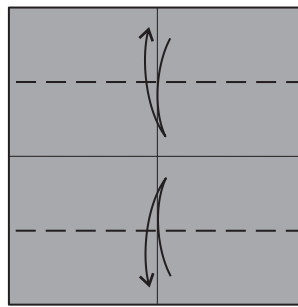

Fold and unfold the edges to the middle crease. Then turn over left to right.

3

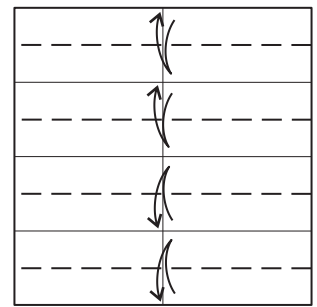

Fold and unfold between the creases made previously. Then turn over left to right.



4

(2-3)
X

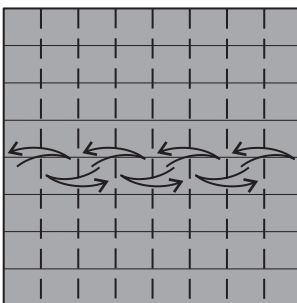

Repeat steps 2 to 3 on the other axis.

5

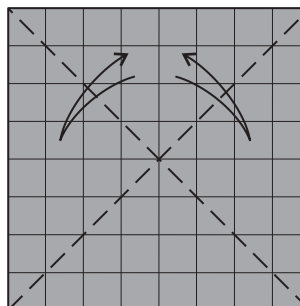

Fold and unfold diagonally along the middle. Then turn the model over left to right.

6

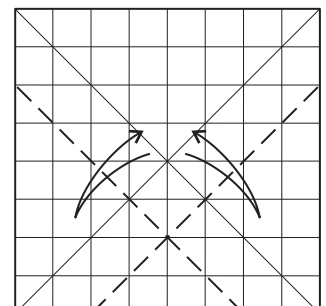

Fold and unfold diagonal folds on either side.



7

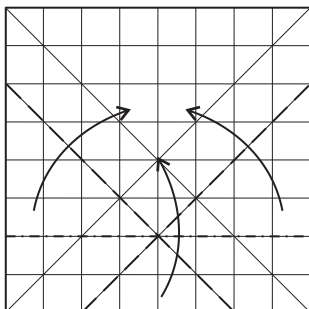

Fold the lower edge up and at the same time fold in the sides.

8

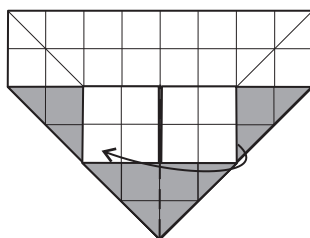

Fold the upper layer over to the left.

9

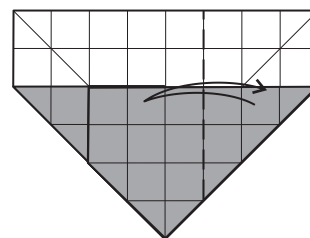

Fold and unfold the outer edge in along the third vertical crease.

10

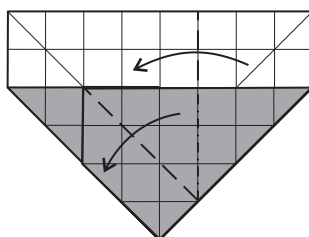

Fold the upper layer down causing the right side to fold in.

11

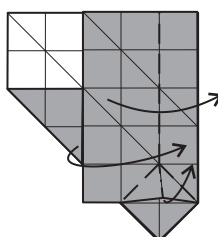

Fold the layers in the upper section back. At the same time reverse fold up the lower corner.

12

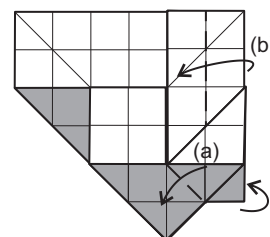

Fold the section over along the diagonal at (a) and fold the triangle to the left. This will cause the outer edge (b) to fold in.

13

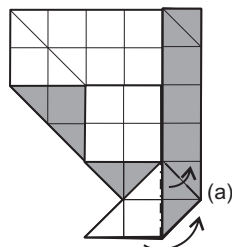

Fold the lower corner up at (a), separate the layers and open the point.

14

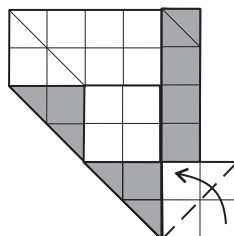

Fold the corner back.

15

(8-14)
↘

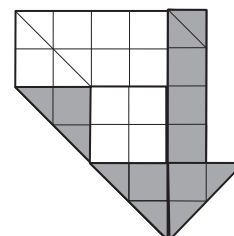

Repeat steps 8 to 14 on the other side. Make sure the corner reversed in step 11 is folded correctly

16

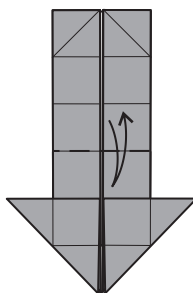

Fold and unfold along the third crease.

17

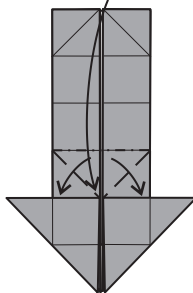

Fold out all layers above the edge of the lower triangle. This will open the section and cause the upper edge to fold down.

18

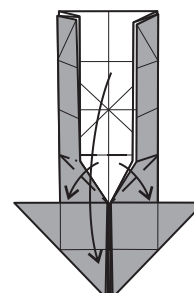

Fold in progress, showing the upper section folding down and opening out.

19

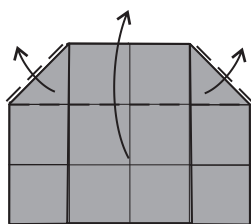

Fold the lower section back up and open out the sides.

20

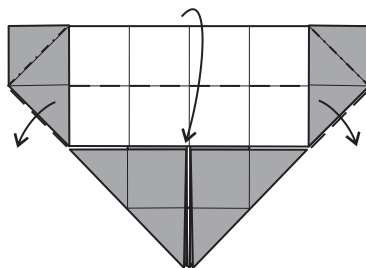

Fold the upper edge down and open out the paper on either side.

21

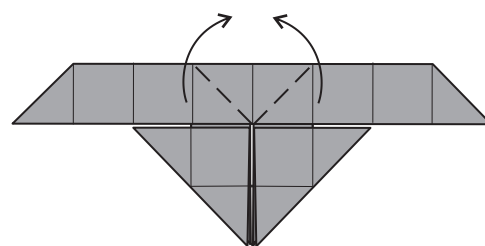

Fold the points up.

22

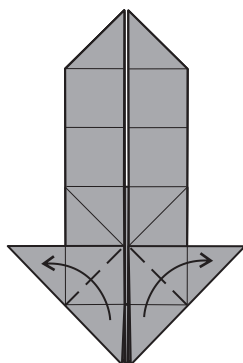

Fold the lower corners up.

23

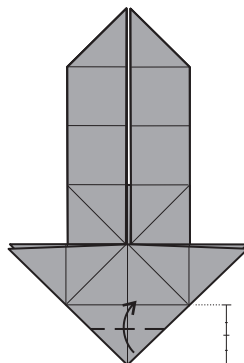

Fold the lower corner up. The corner should lie above the crease about $\frac{2}{5}$ ths of the corner.

24

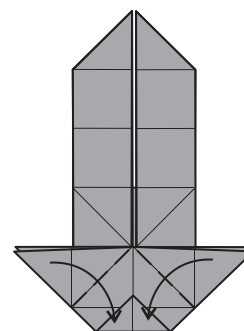

Fold the corners down again.

25

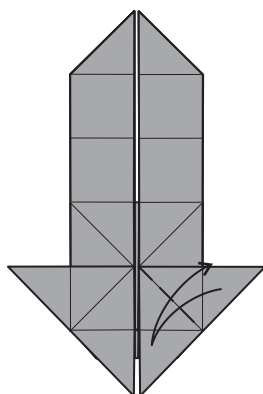

Fold and unfold the corner

26

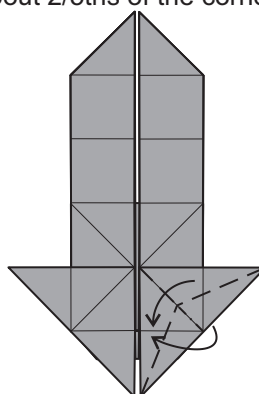

Fold the outer corner over, at the same time reverse fold the edge inside.

27

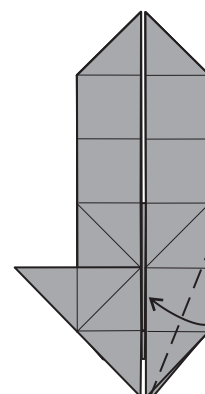

Fold the corner in. If the adjacent layers prevent this check the corner reversed in step 11.

28

(25-27)
↙

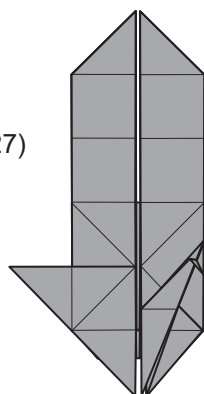

Repeat steps 25 to 27 on the other side.

29

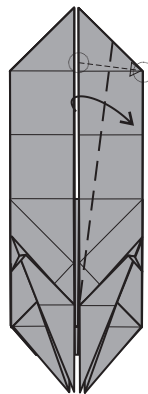

Fold the upper layer over to the right.

30

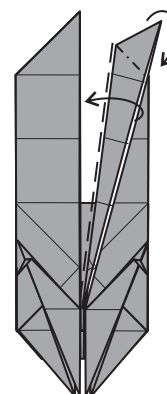

Fold the upper edge back over and open the point.

31

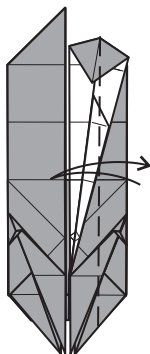

Fold and unfold the outer edge to the middle.

32

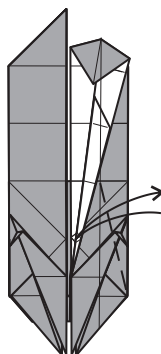

Fold and unfold diagonally.

33

(29-32)
X ↘

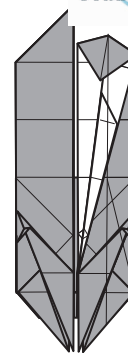

Repeat steps 29 to 32 on the other side.

34

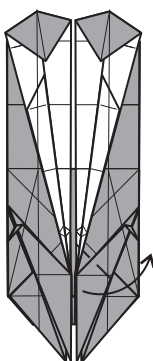

Fold the point up to the right, this will cause the edge of the lower point to open out.

35

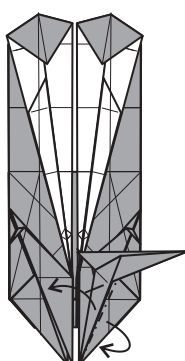

Fold the lower point up to the left. This will cause the edge to fold in narrowing the point.

36

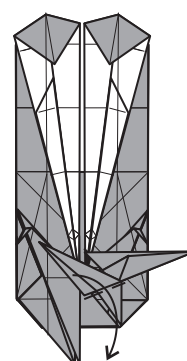

Fold the point back again

37

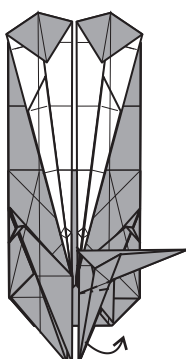

Hold the lower point and slide it to the right.

38

(34 -37)
X ↘

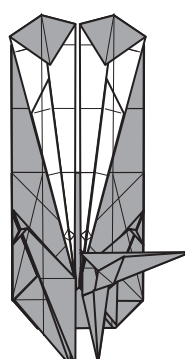

Repeat steps 34 to 37 on the other side.

39

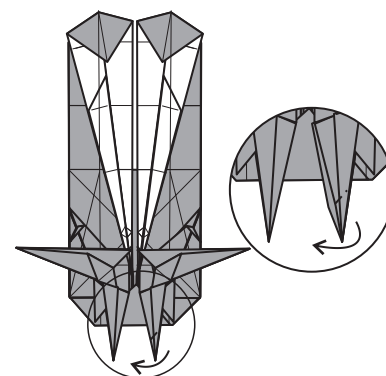

Reverse fold the tip of the point.

40

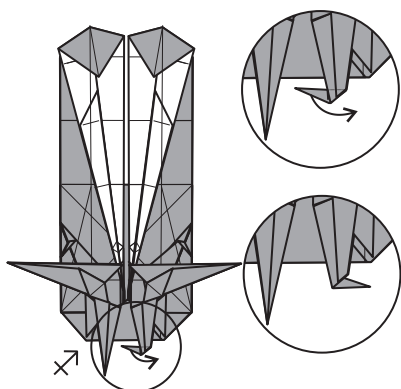

Reverse fold the tip again. Repeat on the other point then turnover.

41

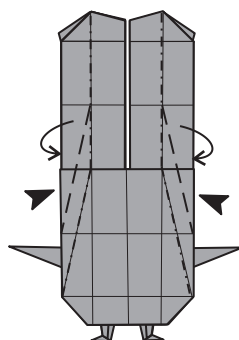

Fold the sides in to shape the head and ears.

42

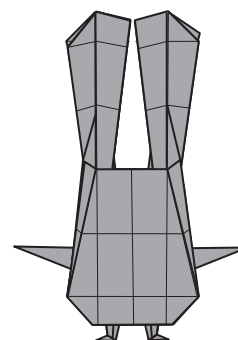

Complete.

SPRIGGAN'S ROCK

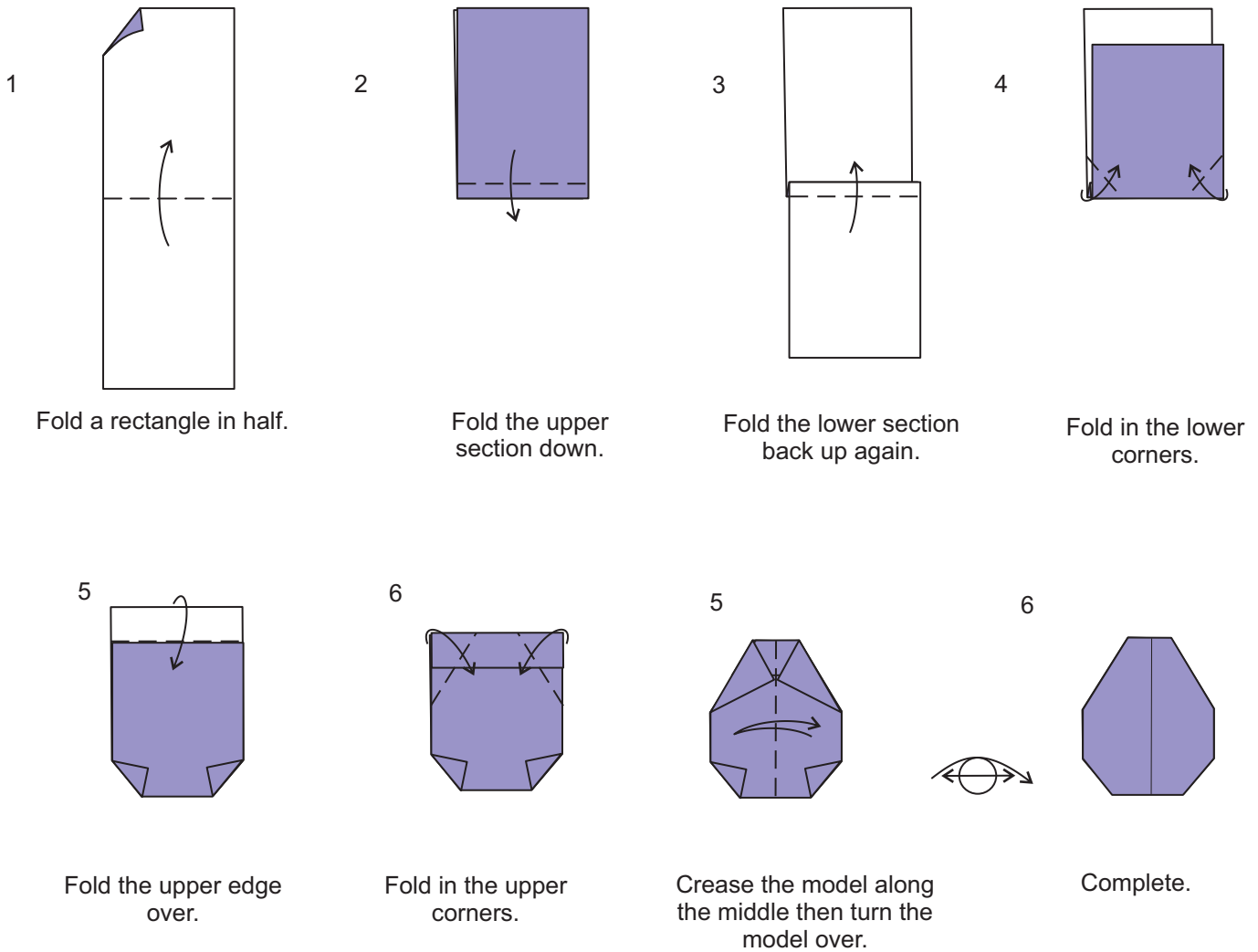

ASSEMBLY

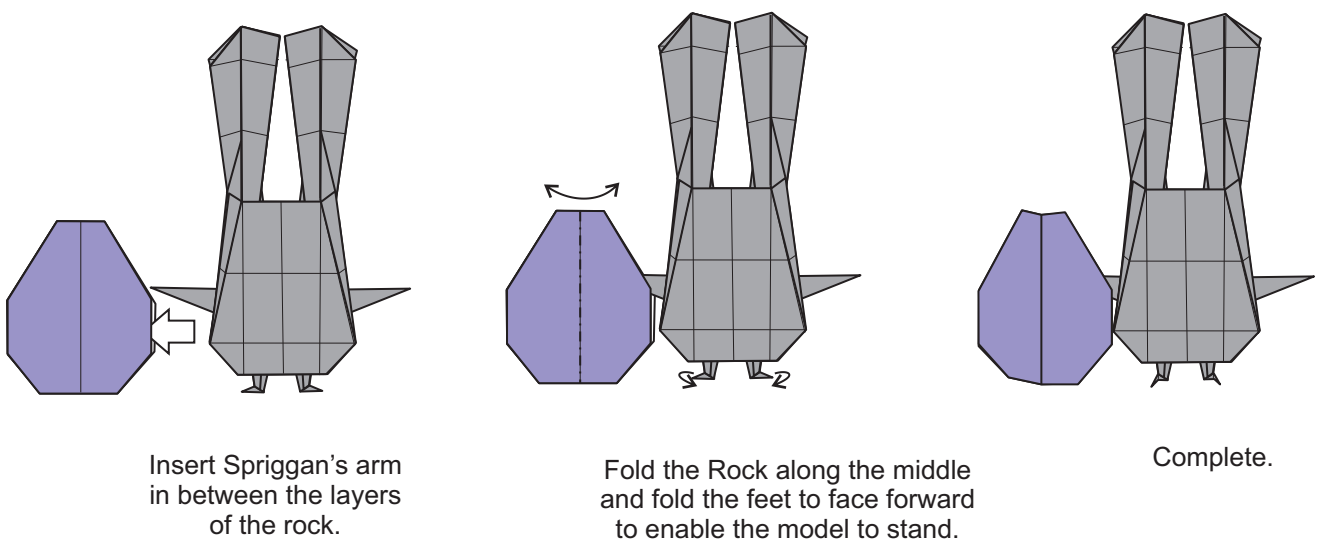

Spriggan

Cut out the square and the rectangle to make the model.

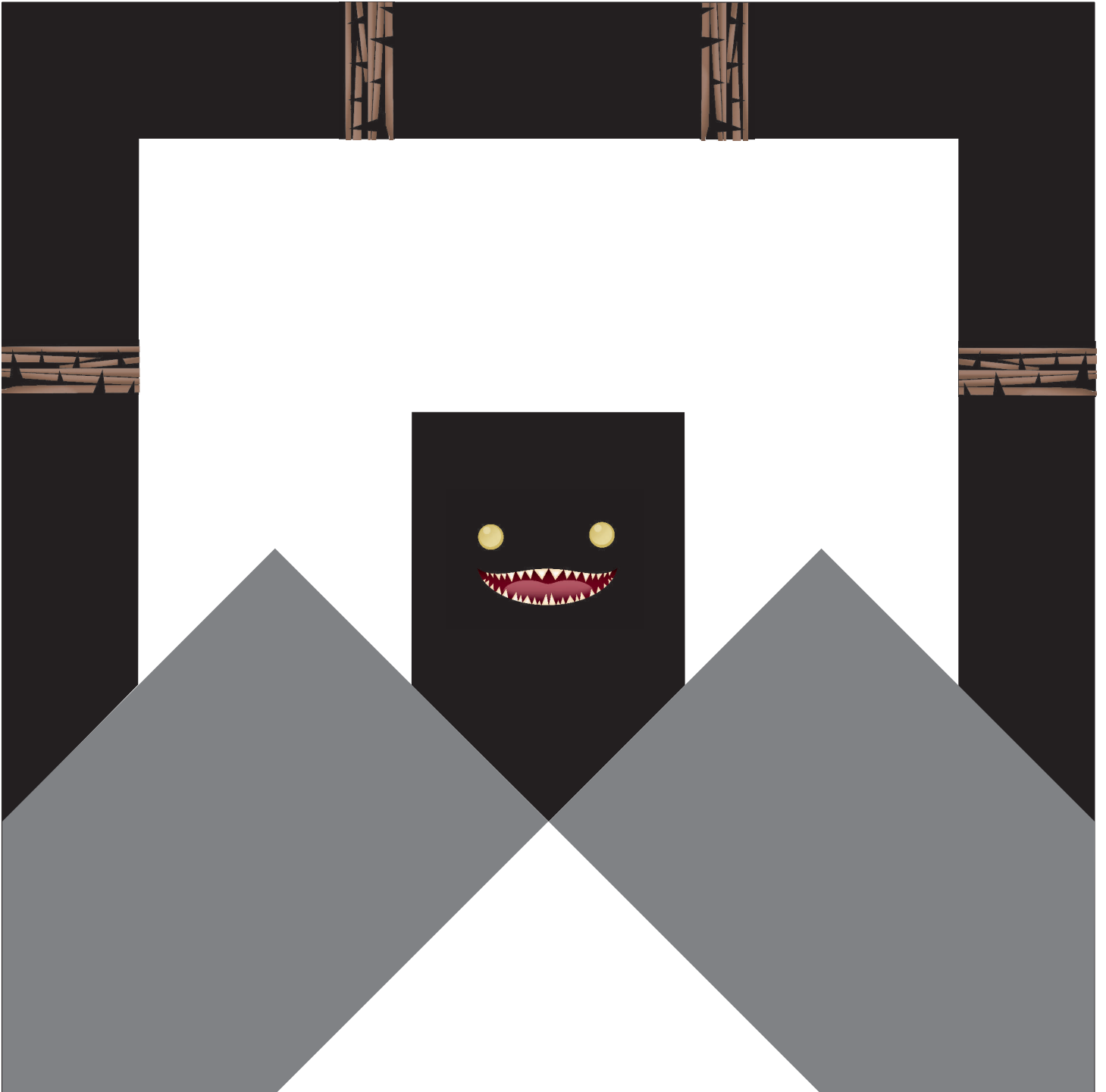
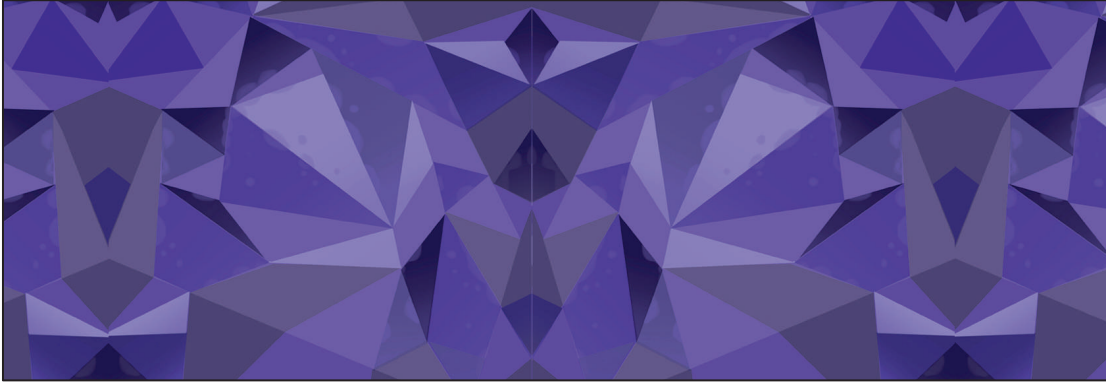

© 2010 - 2017 SQUARE ENIX CO., LTD. All Rights Reserved. NOT FOR SALE.

STORMBLOOD, HEAVENSWARD and A REALM REBORN are registered trademarks or trademarks of Square Enix Co., Ltd.
FINAL FANTASY, FINAL FANTASY XIV, FFXIV, SQUARE ENIX and the SQUARE ENIX logo are registered trademarks or trademarks of Square Enix Holdings Co., Ltd.

Diagrams © 2017 Creaselighting Limited www.creaselighting.co.uk